

(SHEET 7 OF 12)

# Manitowoc Cranes

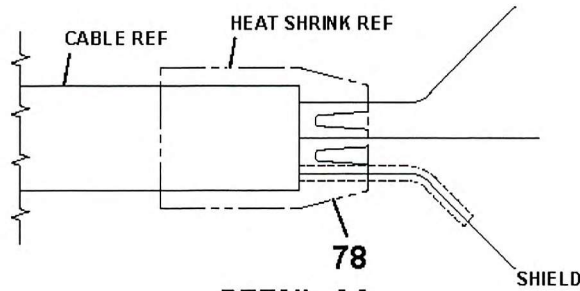

**DETAIL AA**  
CABLE ENDS  
TYP. BOTH ENDS

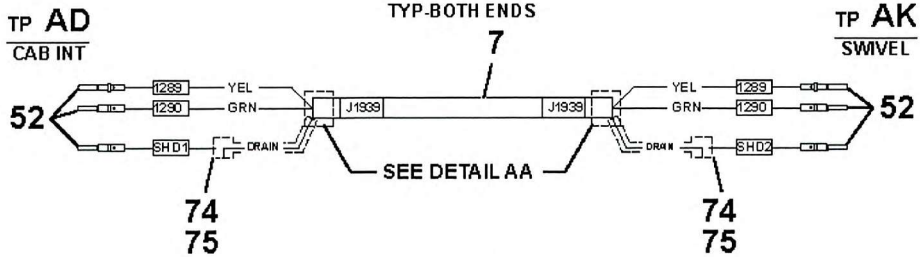

**CABLE DETAIL J1939**

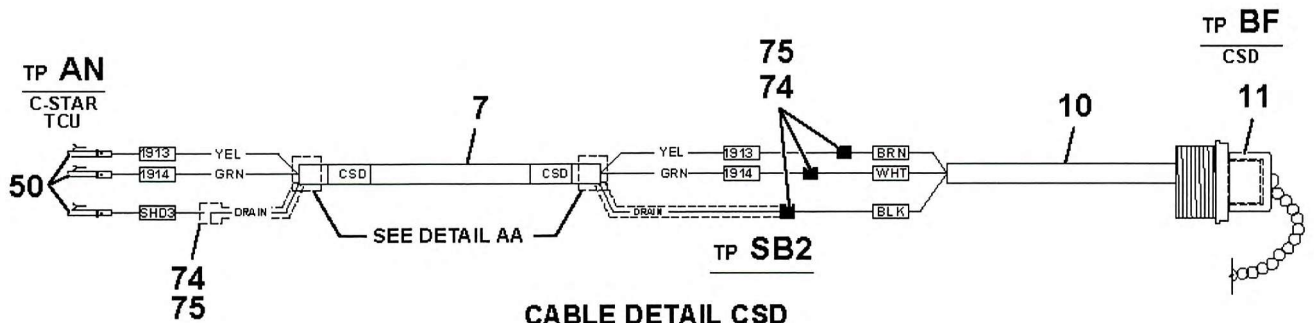

**CABLE DETAIL CSD**

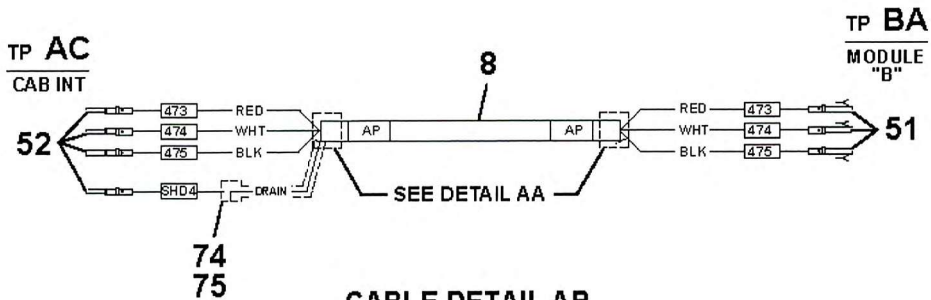

**CABLE DETAIL AP**

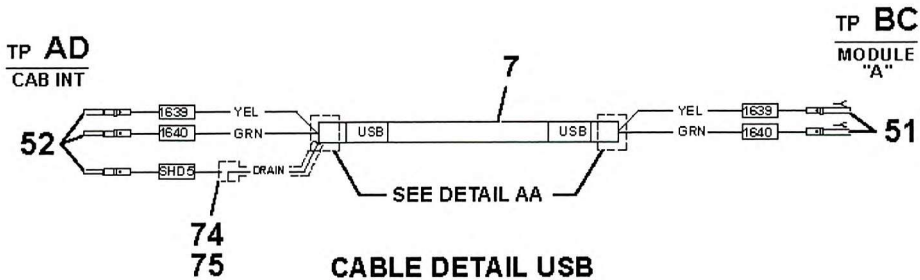

**CABLE DETAIL USB**

80024300

(SHEET 6 OF 12)

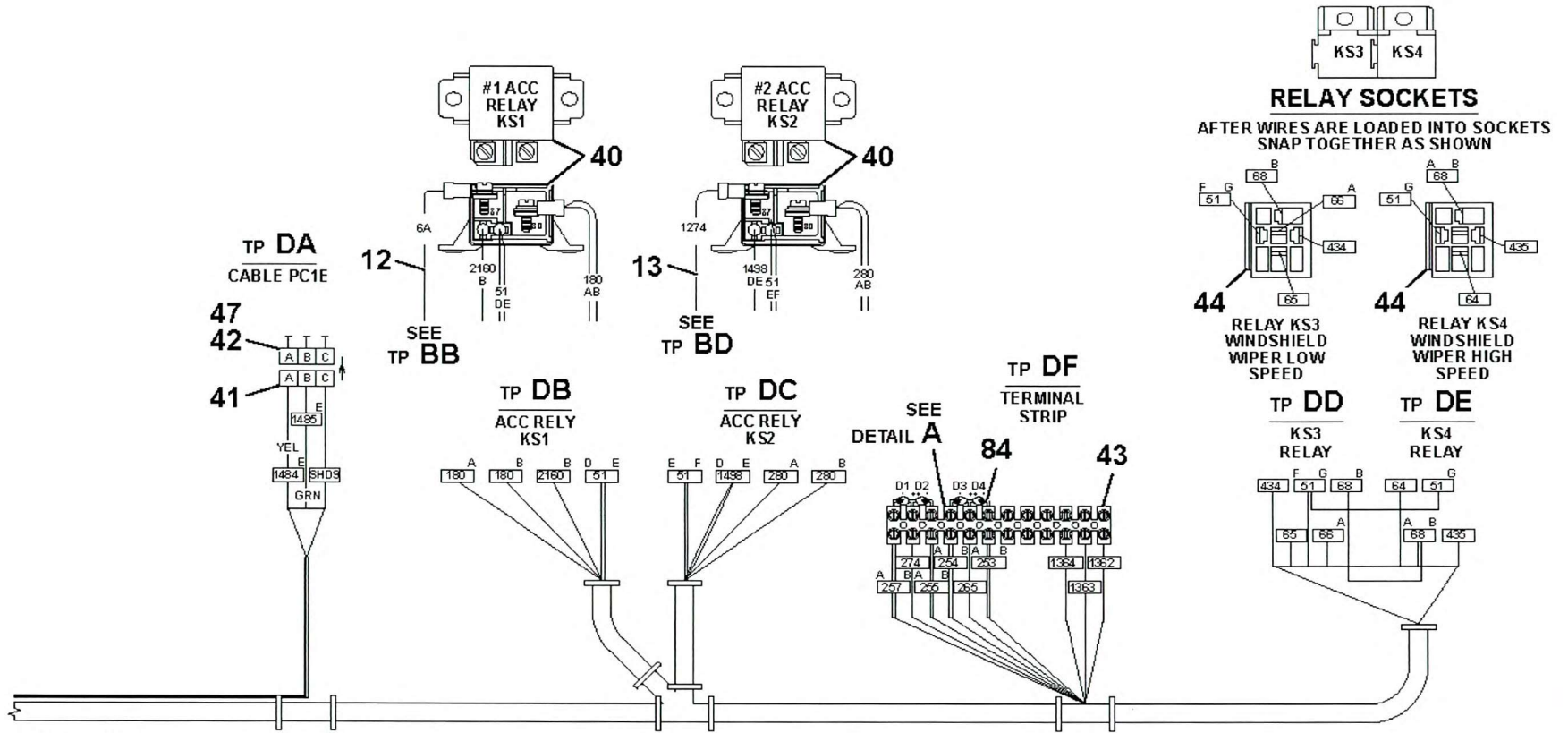

CONTINUED ON SHT 3

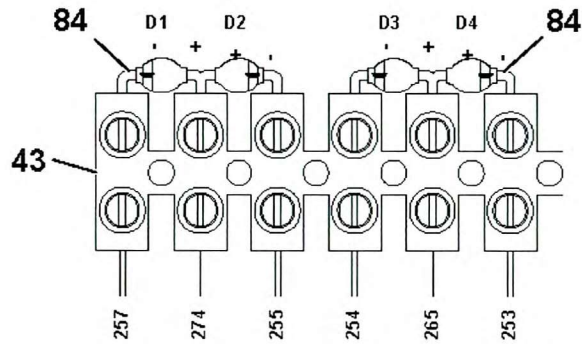

DETAIL A

# Manitowoc Cranes

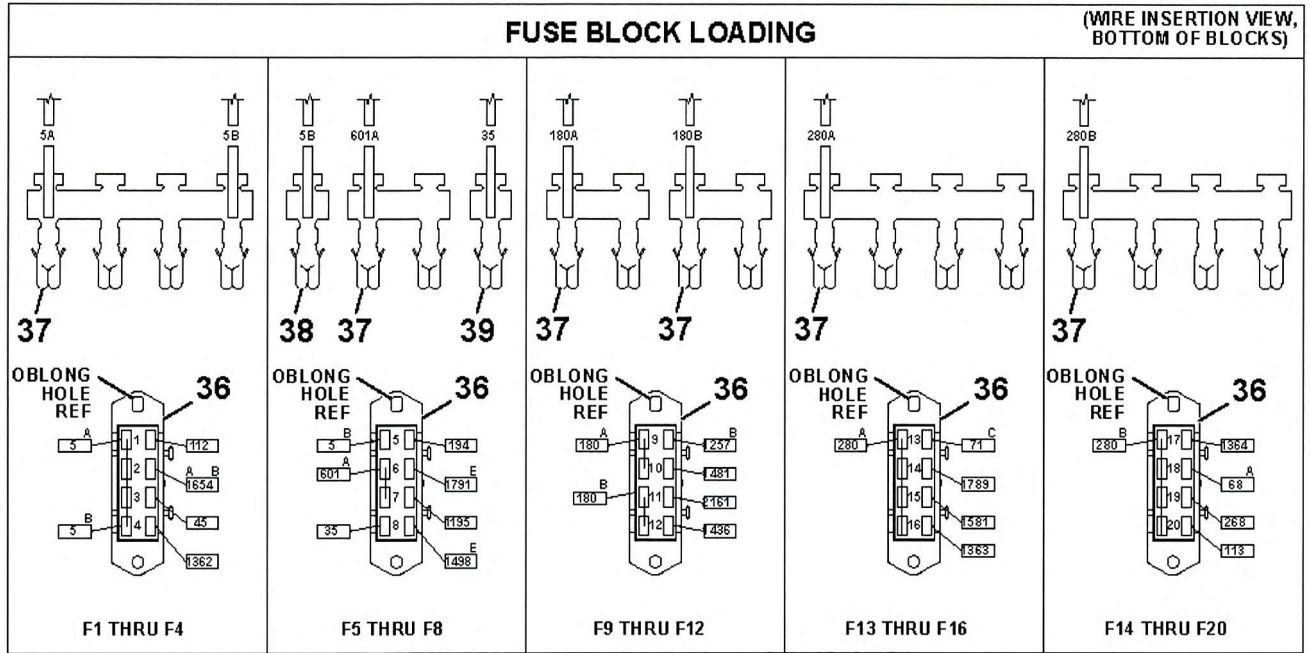

## TOP REAR VIEW

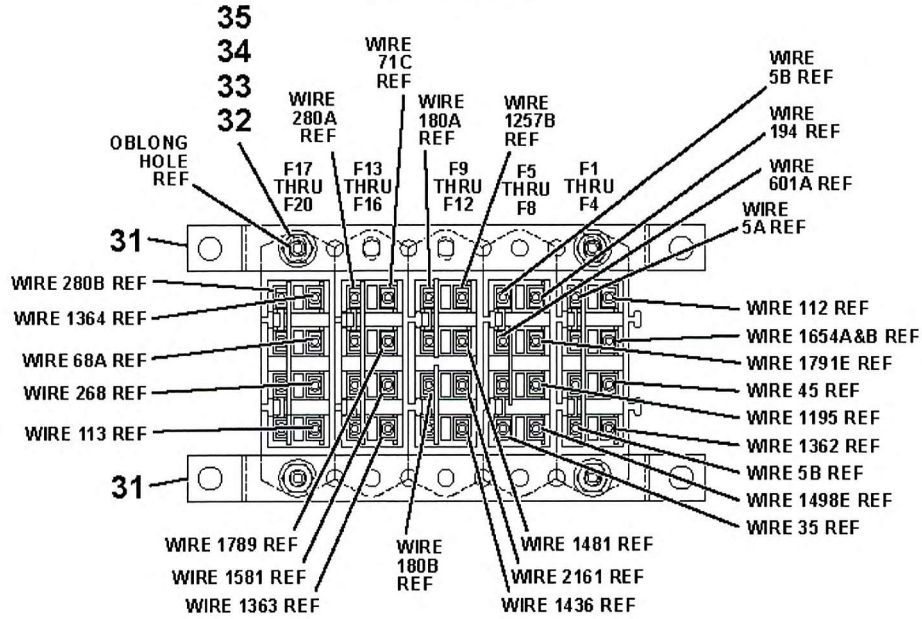

## BOTTOM REAR VIEW

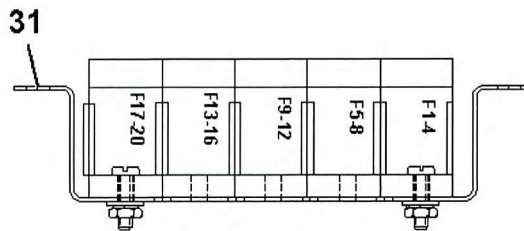

## FUSE BLOCKS

AFTER WIRES ARE LOADED INTO FUSE BLOCKS, LOCK TOGETHER AS SHOWN ABOVE

80024300

(SHEET 4 OF 12)



# Manitowoc Cranes

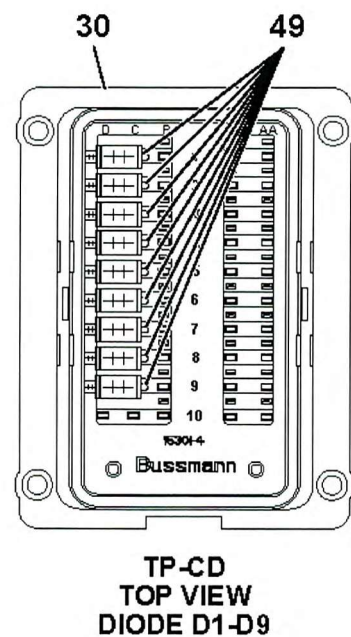
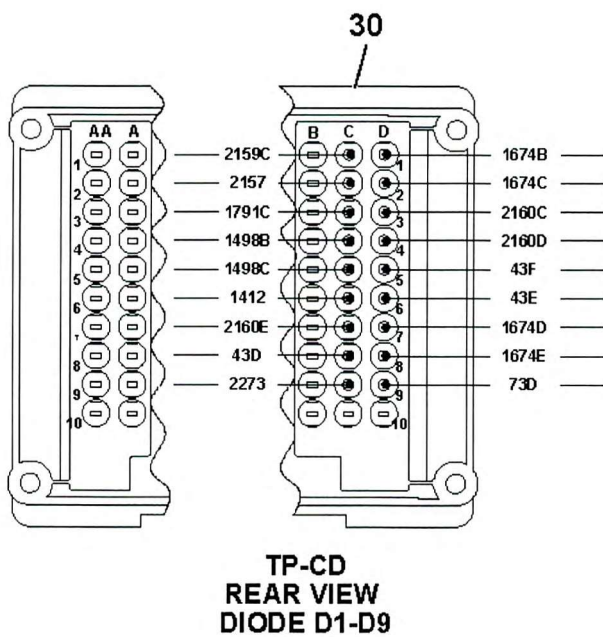
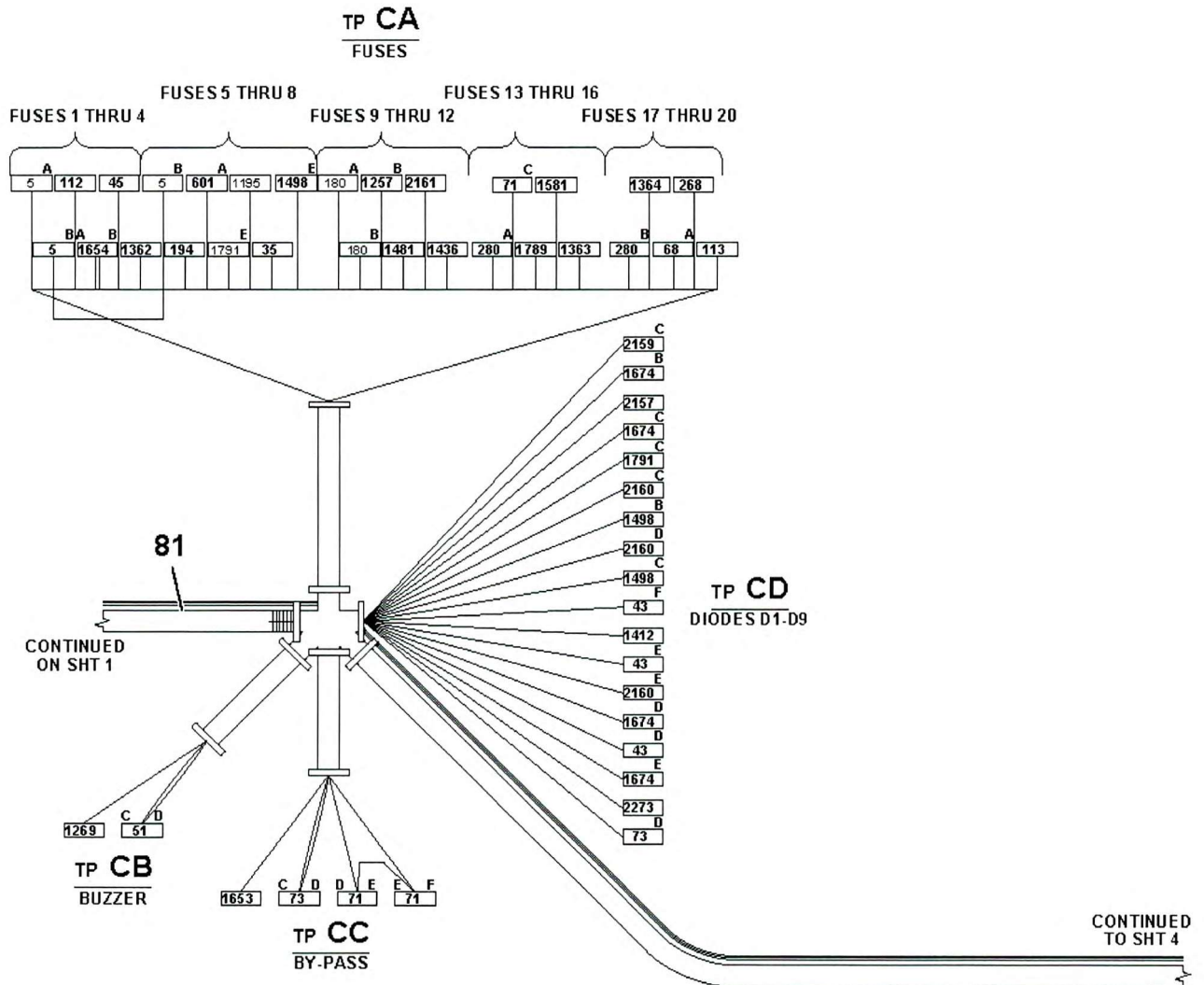

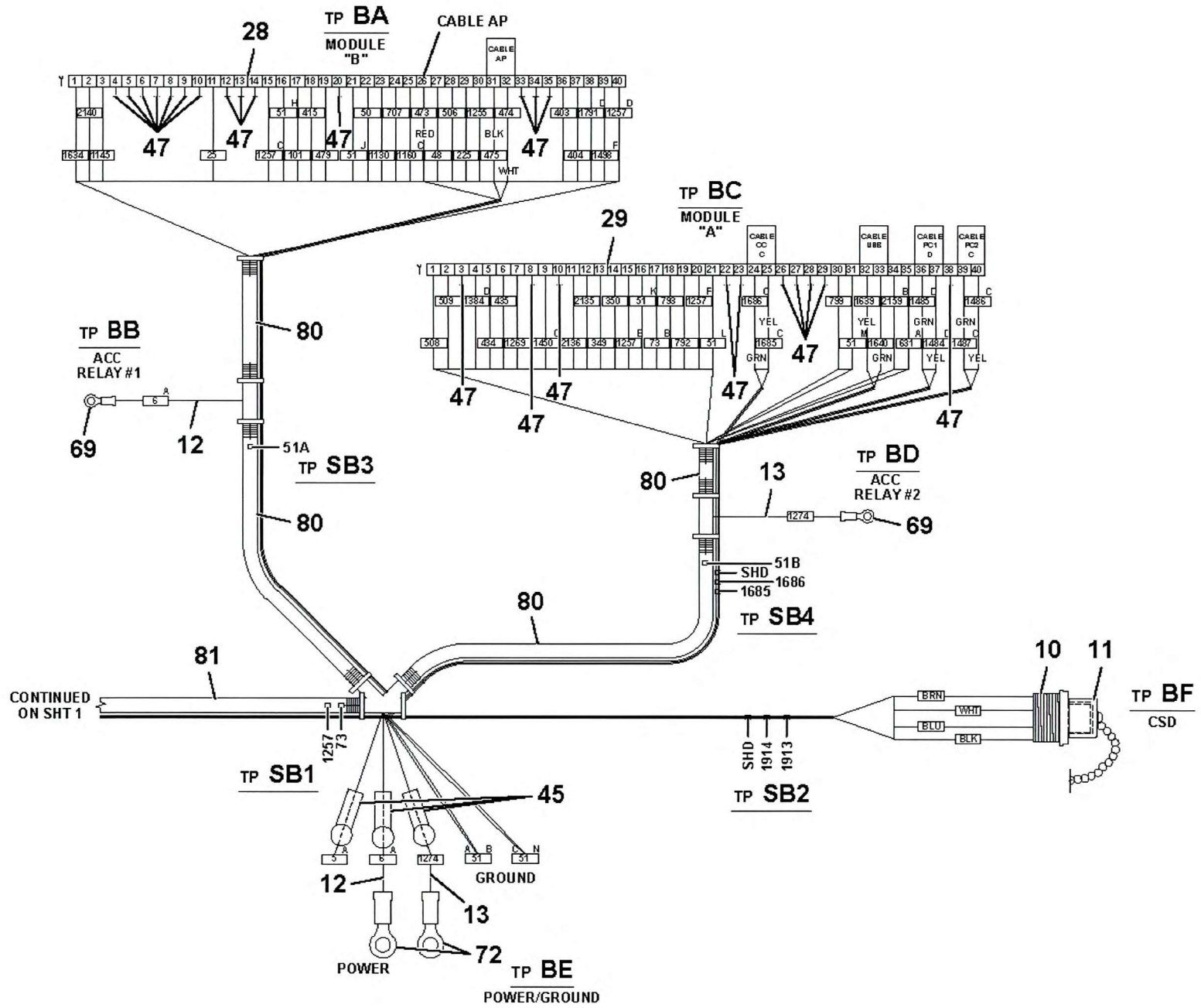

(SHEET 2 OF 12)

